

Article number: 09068540

Description: KLEE Feather keys B 8x5x40 DIN 6885

## Measures

---

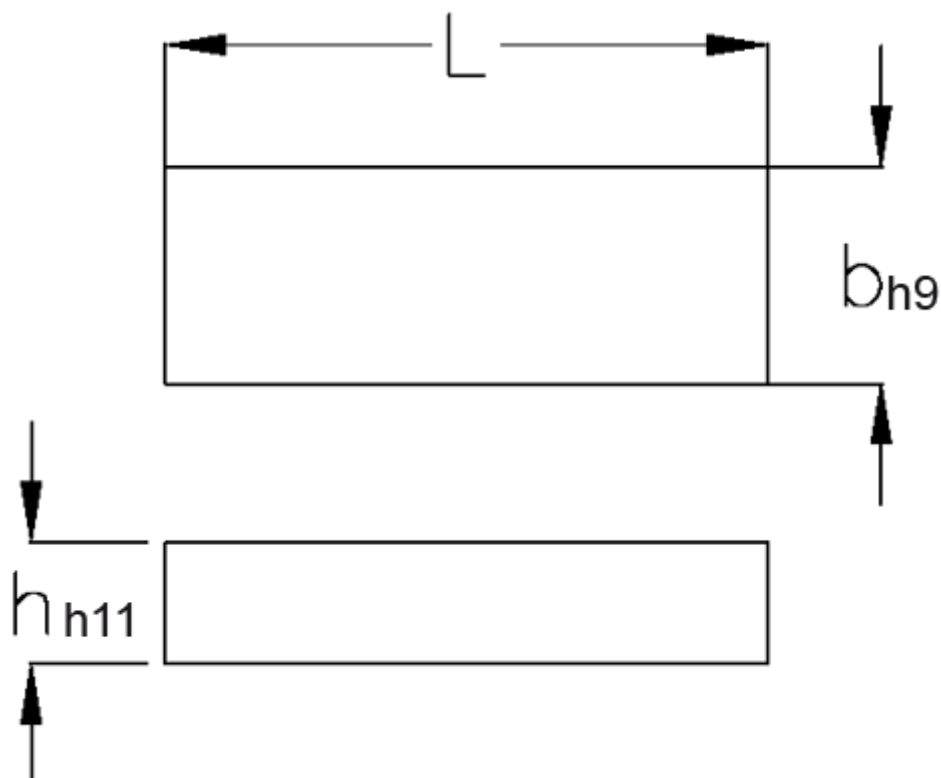

b	= 8
h	= 5
L	= 40
Tolerance b	= 0.036
Tolerance h	= 0.075
Tolerance L	= -0,3